

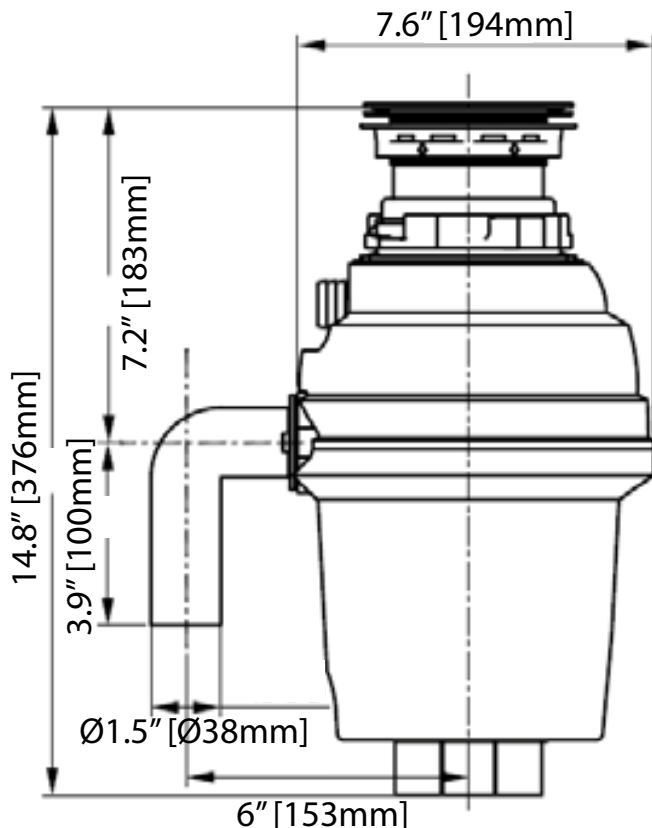

DSA-WD2000

UPC: 813649020748



Suitable For 5-7 People

Motor:

- Continuous Feed
- 1/2 HP
- 60Hz Quiet Permanent Magnet DC Motor
- 120V
- 2500RPM Grinding Speed
- >80% Motor Efficiency
- >1.5N.m Output Torque
- 1070mL Hopper Capacity

Noise Level:

- ~ 65 dB - 68 dB

Materials:

- Stainless Steel Armature Shaft
- High-speed Dynamic Balanced Armature
- Permanently Lubricated, Sleeve Type Bearing
- High-speed Dynamic Balanced Stainless Steel Turntable
- 1 Piece High Efficiency Stainless Steel Grinding Rings
- 114 Round Hole & 12 Arch Cutters
- Cast, Never Broken, Wear-resistant, Jam-resistant Special
- Stainless Steel, Dual-swivel Impellers
- G0.4 Balance Level
- Insulated Sound Elimination for Quiet Operation
- Stainless Steel Multifunctional Sink Stopper
- Stainless Steel Sink Flange
- Double Seal, No leakage Anti-aging Rubber Cushion
- Mount Ring
- Glass Fiber Reinforced Nylon Corrosion-proof Hopper
- Hexagonal, Glass Fiber Reinforced Polymeric Material

Includes:

- EPDM Removable Splash Guard
- Drain Housing
- Drain Connector
- (White/Black) Drain Elbow
- Enhanced Engineered Plastic Upper & Lower Shell
- Double protection for Over Load and Temperature Manual Reset Protector
- Attached Power Cord and Plug
- 95+/-5mm Power Cord
- 90~160mm Sink Calibre
- Built-In Air Switch

Safety:

- Bio-guard Antimicrobial Protection
- Septic Safe

Warranty:

- 10 Year Limited Warranty

